

玄関前階段階下等 平面詳細 1/50

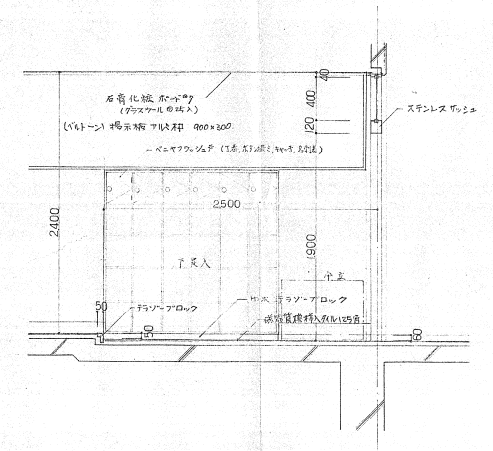

a-a 詳細図 1/30

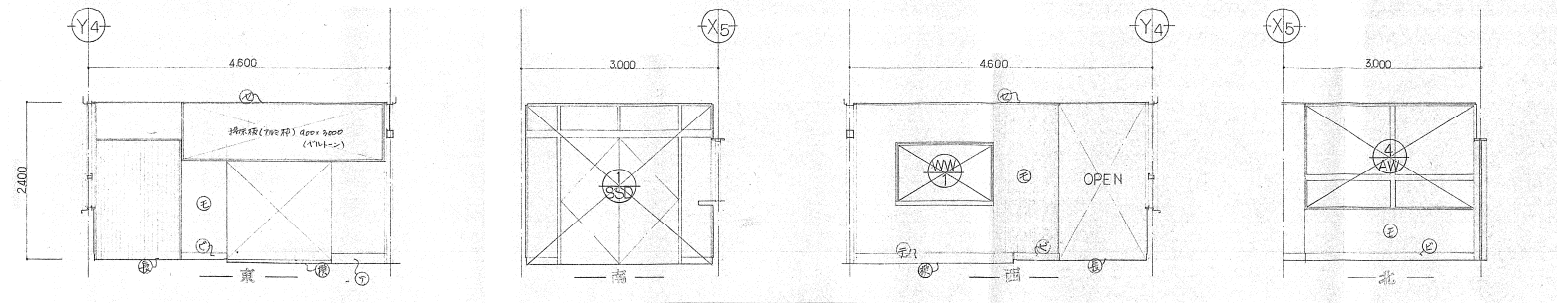

玄関ホールの展開図 1/50

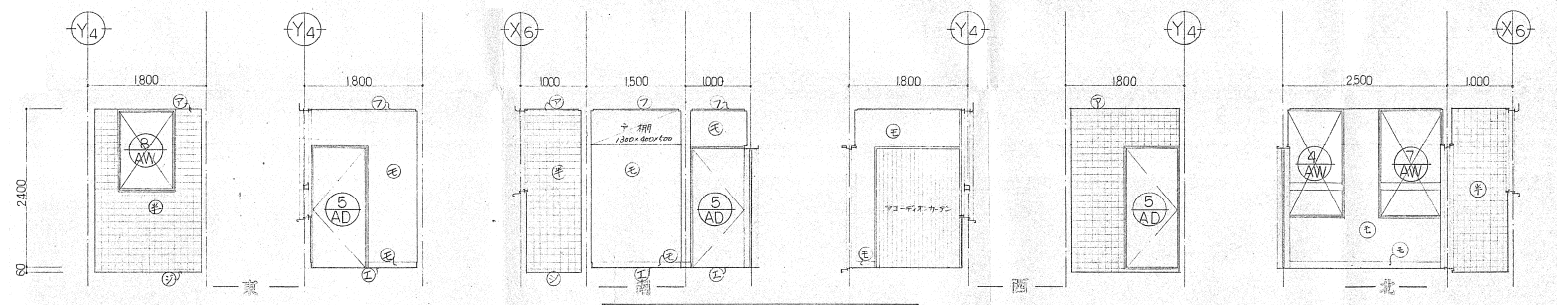

法面階段の展開図 1/50

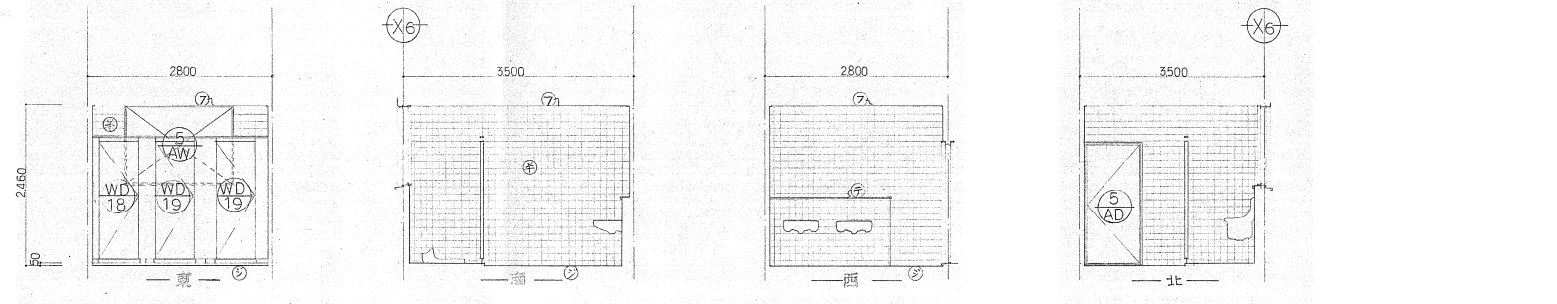

リビングの展開図 1/50

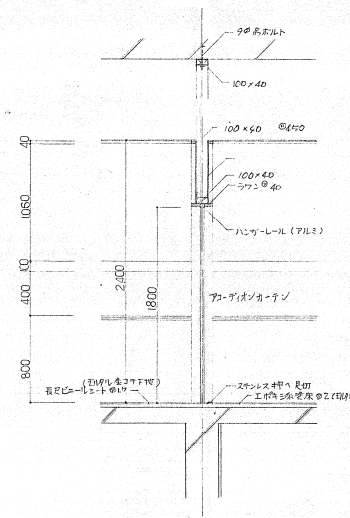

b-b 詳細図 1/30

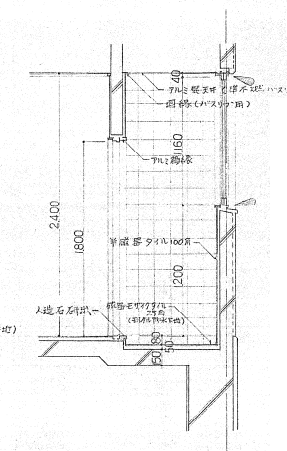

c-c 詳細図 1/30

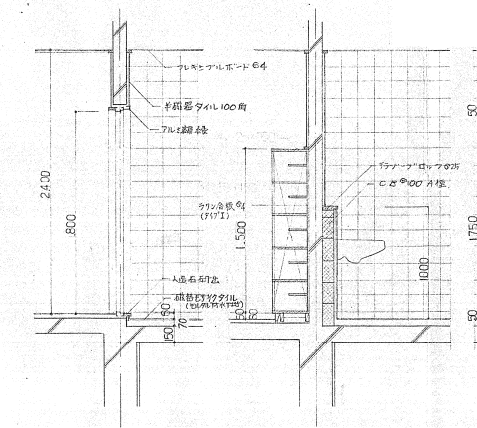

d-d 詳細図 1/30

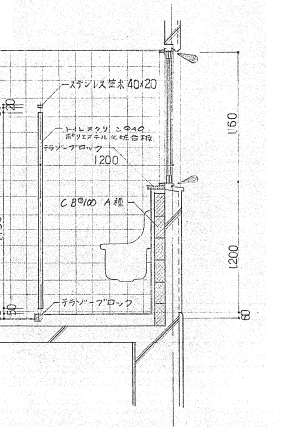

e-e 詳細図 1/30



f-f 詳細図 1/30



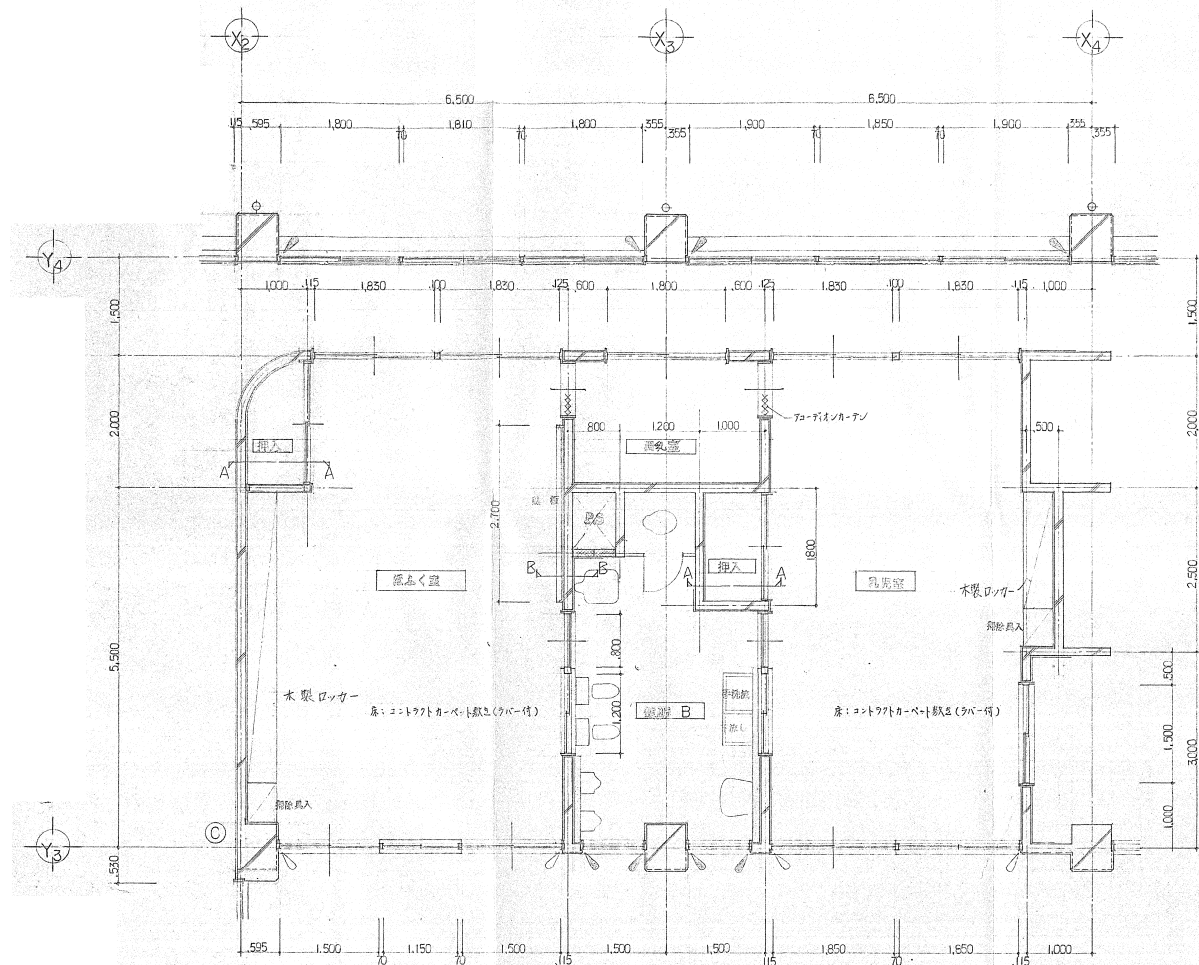

洗面室・脱衣室 詳細図 1/50

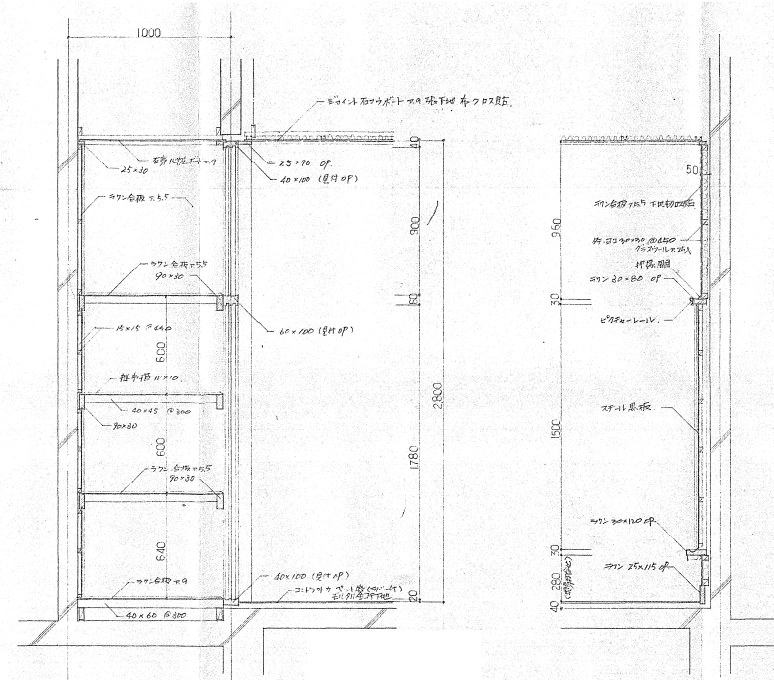

A-A 詳細図 1/20

B-B 詳細図 1/20

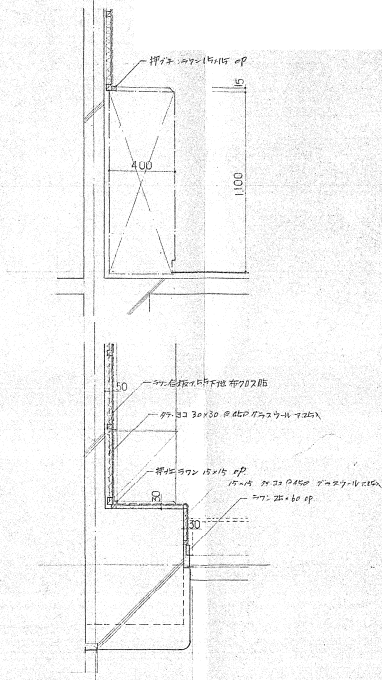

C 詳細図 1/20

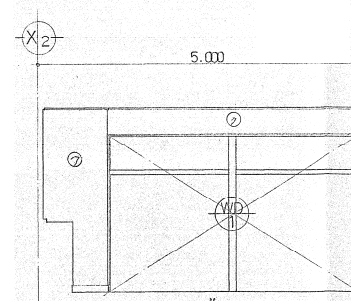
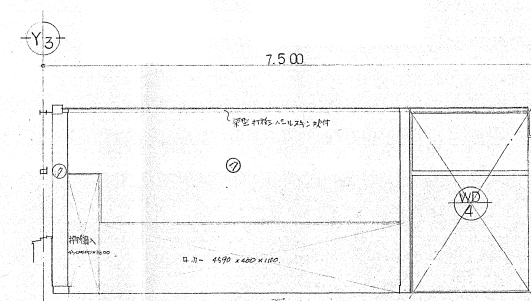
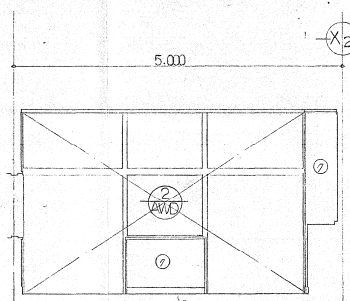
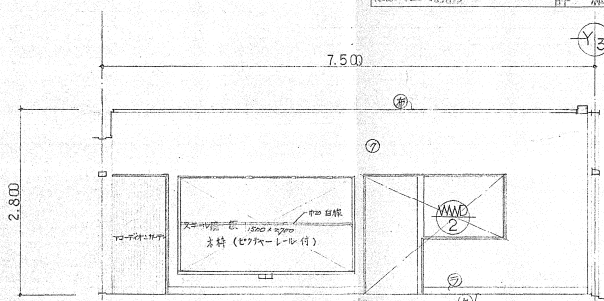

洗面室 展開図 1/50

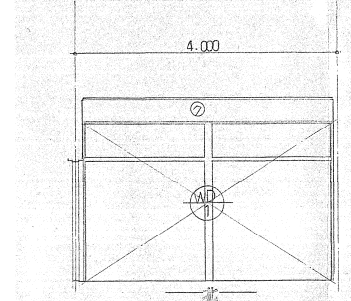
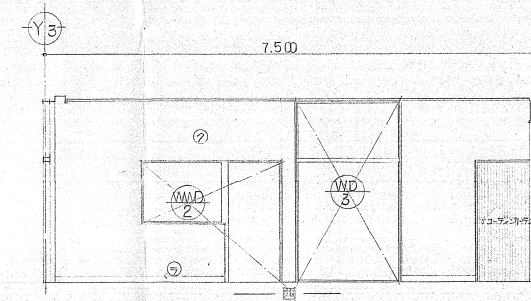
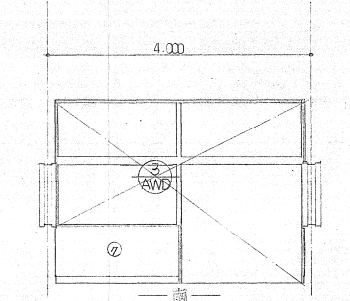
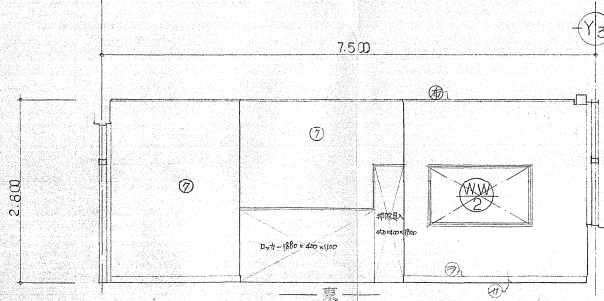

脱衣室 展開図 1/50

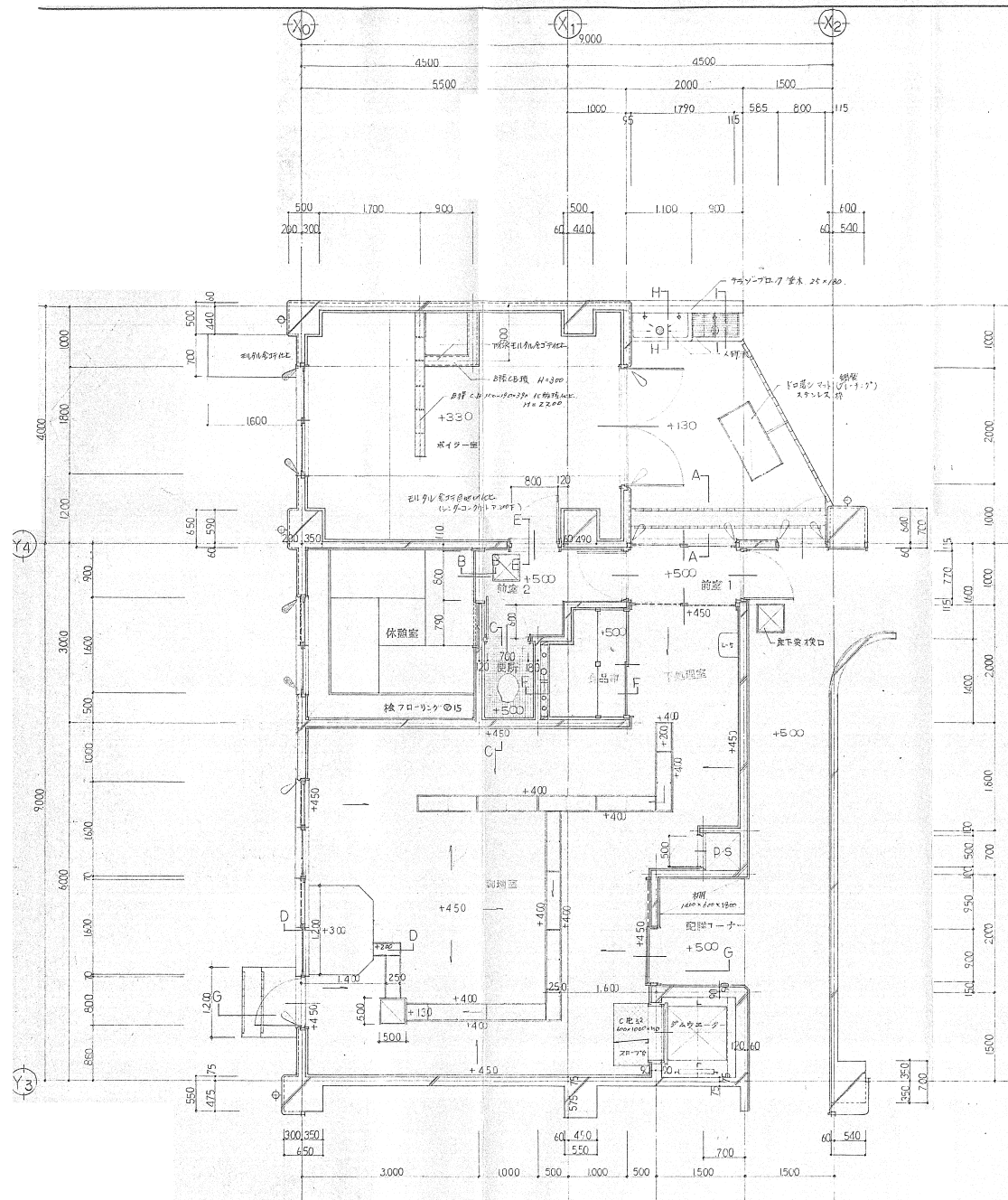

調理室 休憩室 トイレ 下処理室 平面詳細 1/50

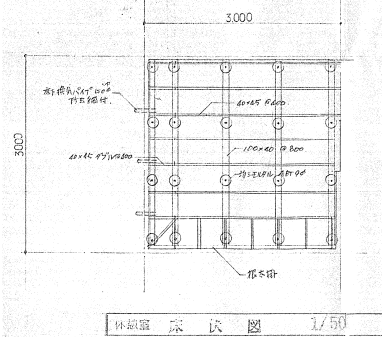

柱梁図 床 図 1/50

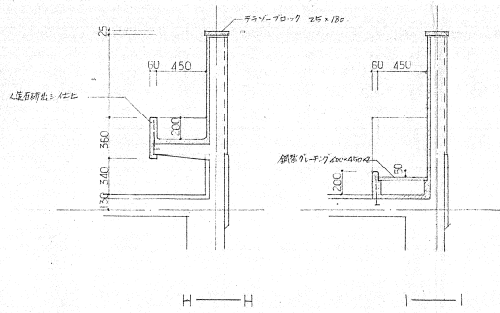

H-H I-I

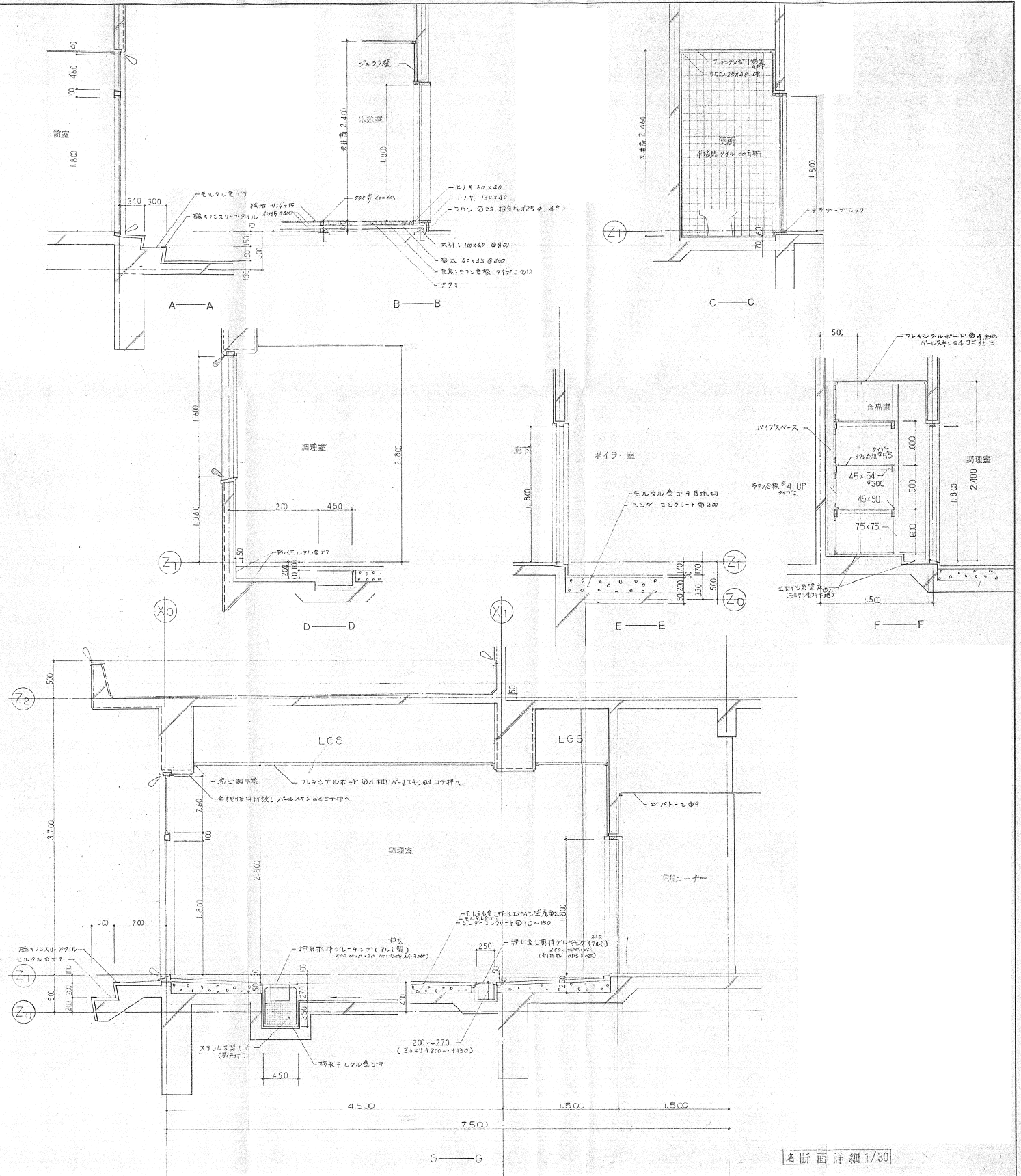

断面詳細 1/30

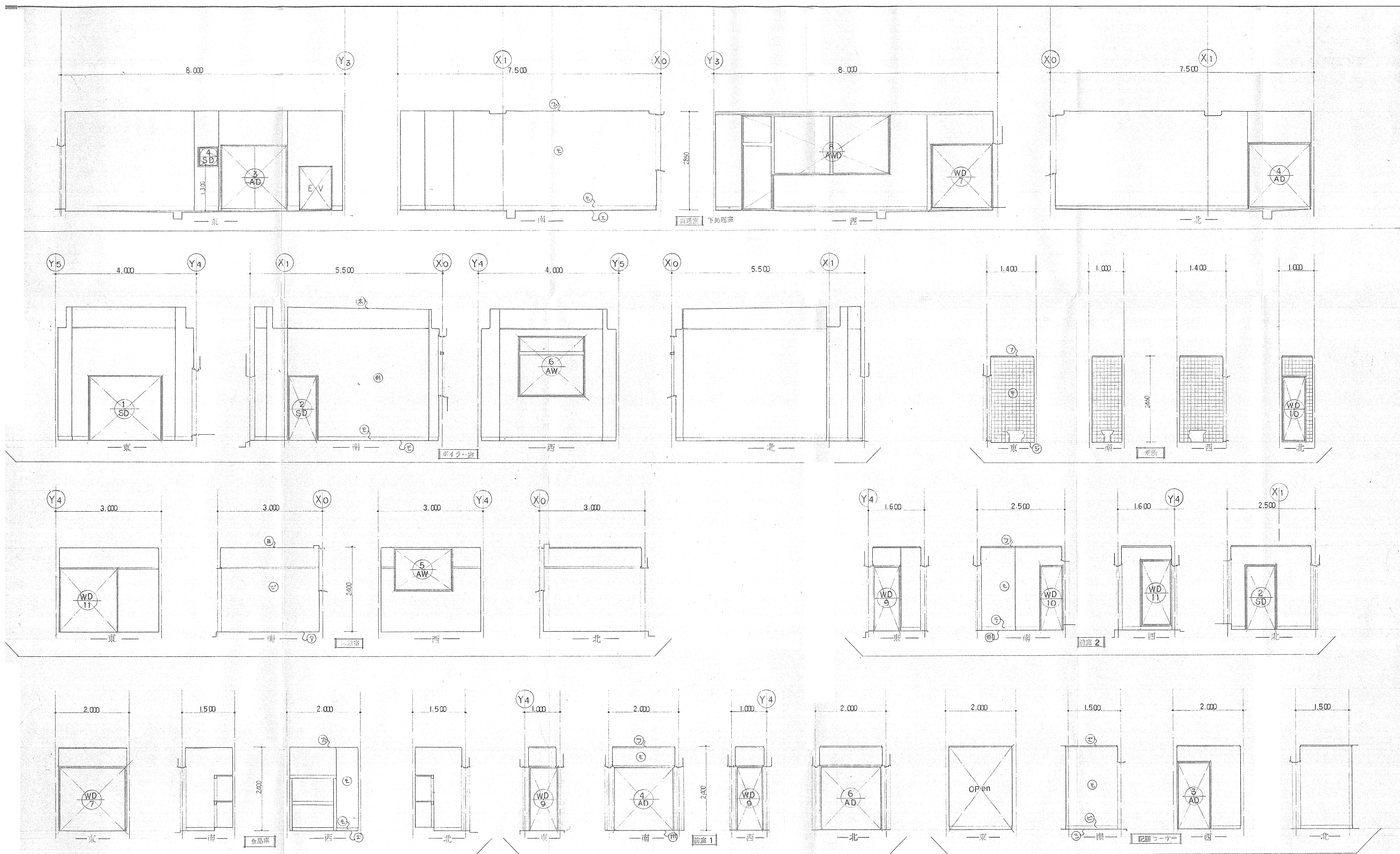

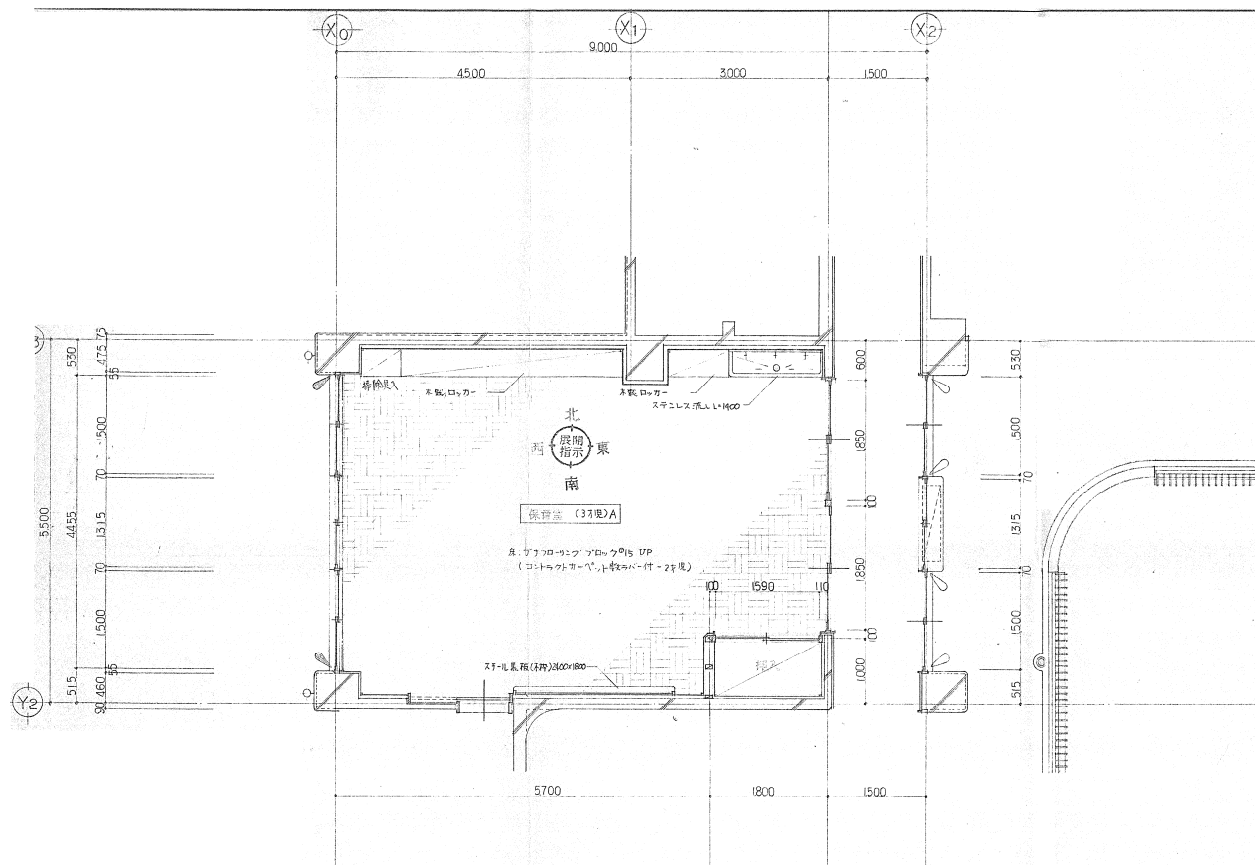

保育室 (33号)A 平面詳細 1/50  
(2号)A

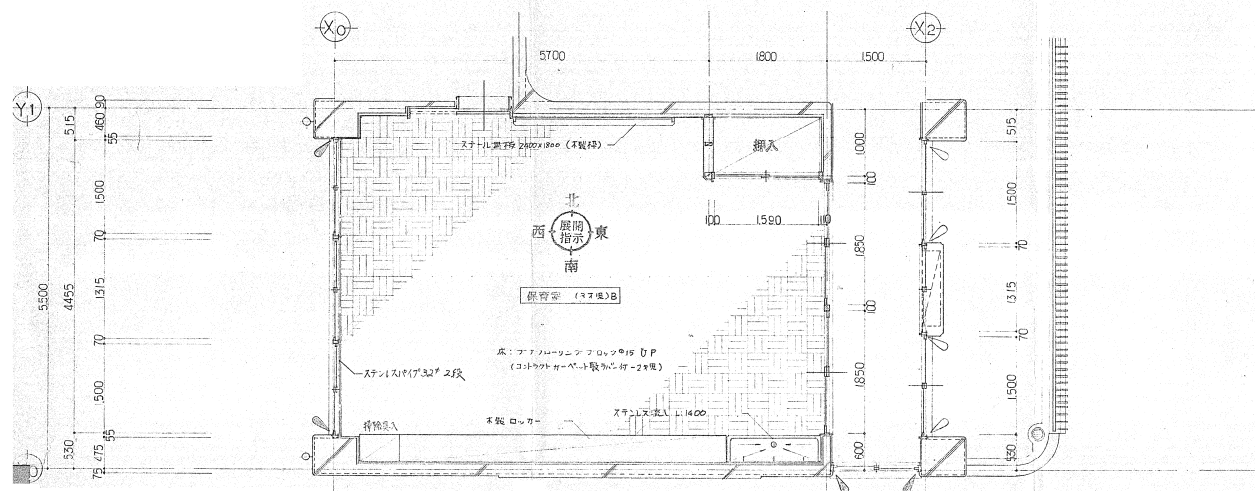

保育室 (33号)B 平面詳細 1/50  
(2号)B

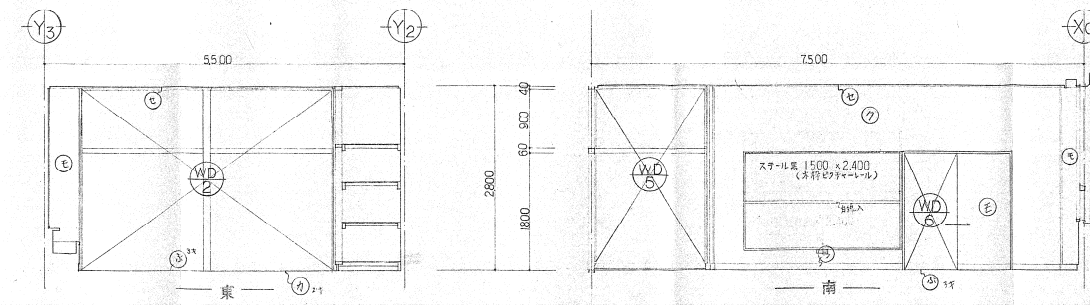

保育室 (33号)A 展開図 1/50  
(2号)A

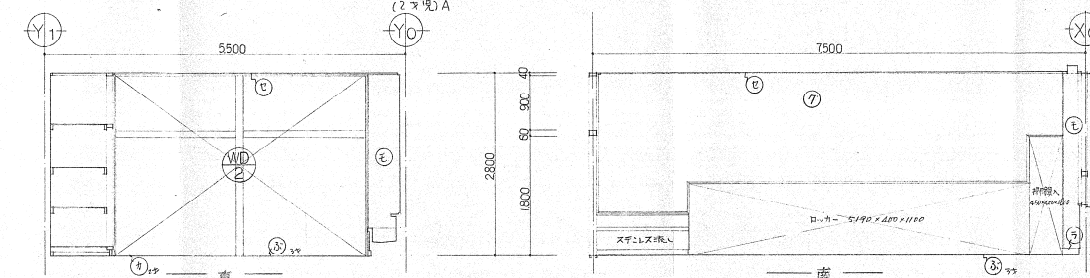
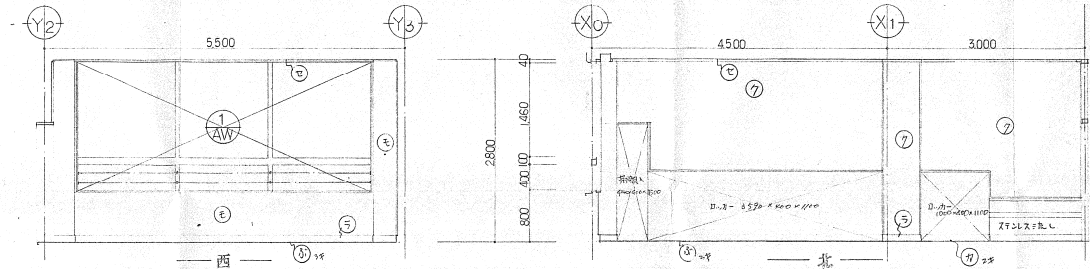

保育室 (33号)B 展開図 1/50  
(2号)B

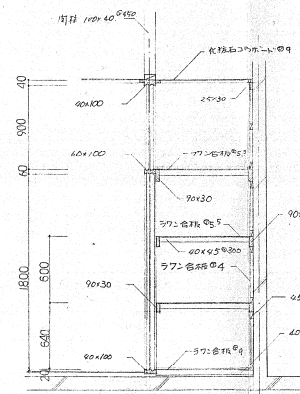

押入 扉枠入 詳細図 1/30

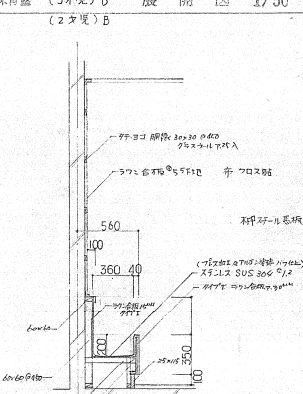

スチール流し 詳細図 1/30

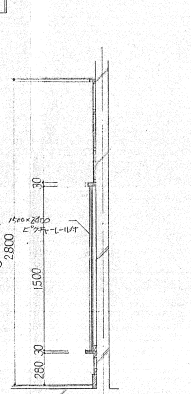

扉枠取付 詳細図 1/30

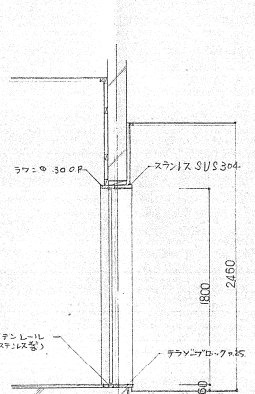

扉所出入口 詳細図 1/30



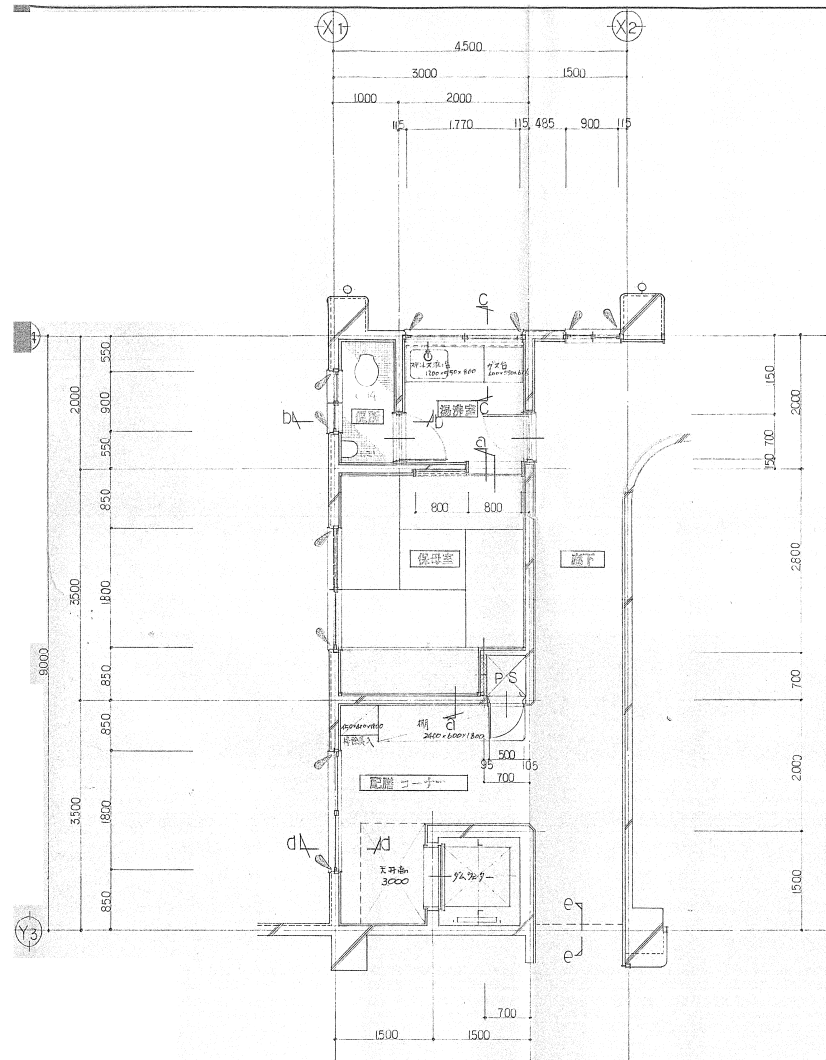

保育室・廊下・トイレ・調理室平面詳細 1/50

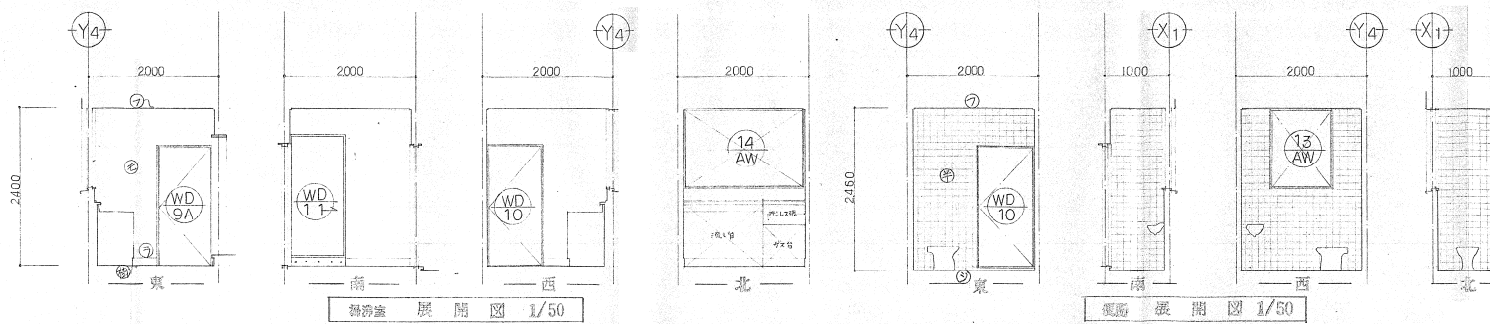

保育室 展開図 1/50

トイレ 展開図 1/50

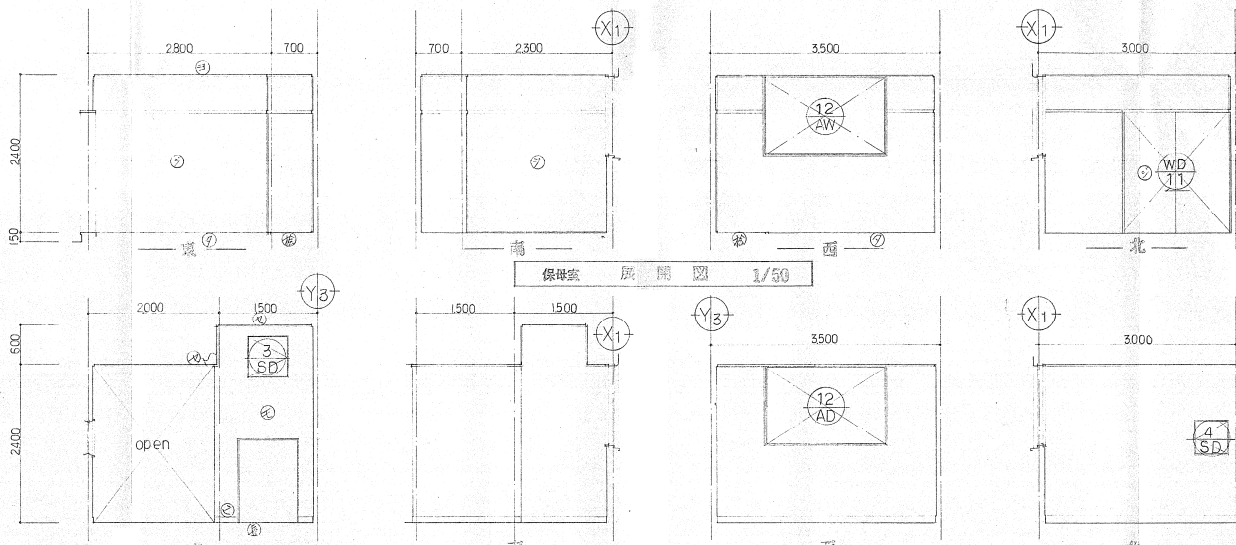

保育室 展開図 1/50

調理室 展開図 1/50

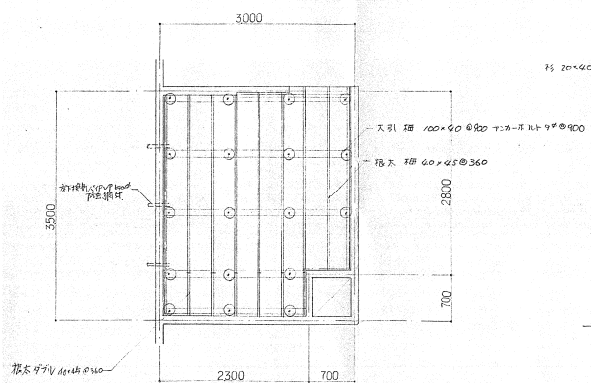

保育室床伏図 1/50

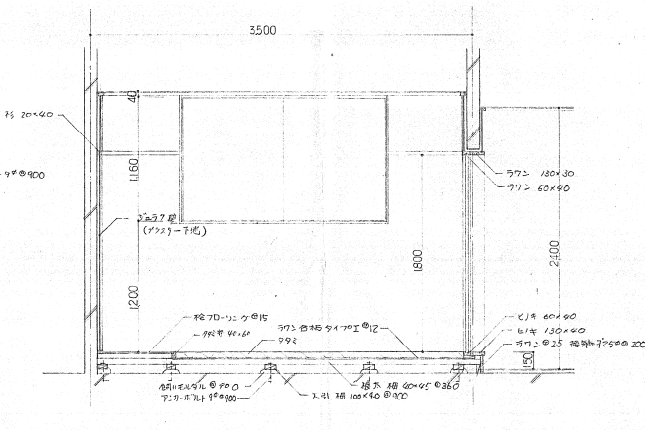

c-a 詳細図 1/30

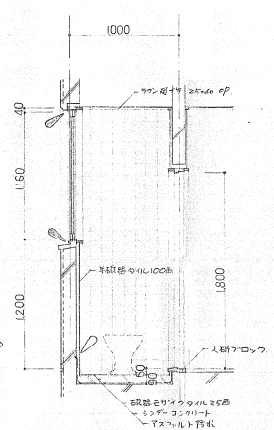

b-b 詳細図 1/30

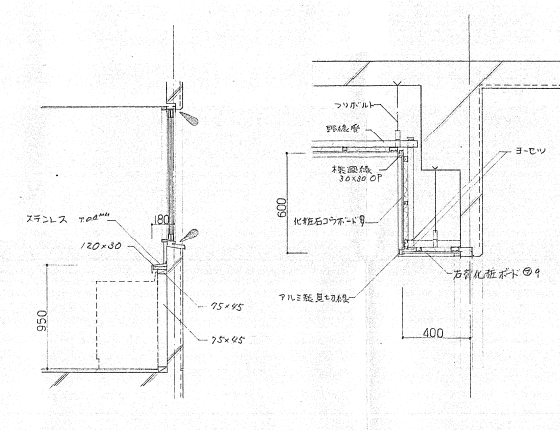

c-c 詳細図 1/30

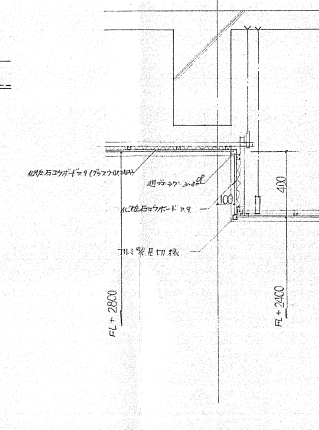

d-d 詳細図 1/20

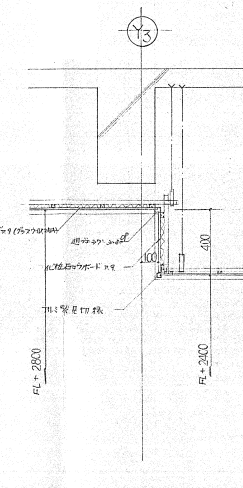

e-e 詳細図 1/20

